



Electrolux
PROFESSIONAL

Standard Preparation 700 mm Sink with 1 Bowl

ITEM # _____

MODEL # _____

NAME # _____

SIS # _____

AIA # _____



132803 (LG716PN)

Sink Unit with 1 bowl
500x500x300mm, 700mm

Short Form Specification

Item No. _____

Made from 304 AISI stainless steel. The 50mm high worktop in 304 AISI stainless steel, 1mm in thickness, is sound-deadened and has an overflow rim and welded corners. Integral rear upstand, h=100mm, with 8mm radius. All-round apron. Square section legs 40x40mm on 1" height-adjustable feet (+/-20mm)

Bowl mm500x500x300h with overflow pipe and 2" drain hole.

Construction

- 50 mm worktop in 304 AISI stainless steel, 10/10 in thickness with overflow rim along the top.
- Square section legs and 40 mm height-adjustable feet in 304 AISI stainless steel.
- Sink tops easily slotted onto the legs and taps are easily installed from the rear.
- 100 mm upstand with 10 mm radiused corner and 13 mm deep, designed to be used against a wall.
- Delivered in knock-down package.
- Wide range of taps are available to suit every need.

Optional Accessories

- Set of 4 wheels (2 with brake) PNC 855150
d. 100mm for tables and sinks
(total height on wheels= 993 mm)
- Elbow operated mixer tap with PNC 855322
spout 3/4", single hole
- Elbow operated mixer tap with PNC 855323
short spout 3/4", single hole
- Foot operated mixer tap (hot PNC 855328
and cold) with spout 3/4"
- Single plastic drain syphon 2 PNC 895313
" for Sinks

APPROVAL: _____



Experience the Excellence
www.electroluxprofessional.com

Front

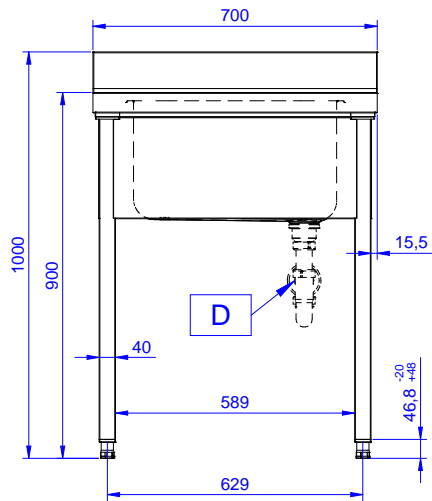

Side

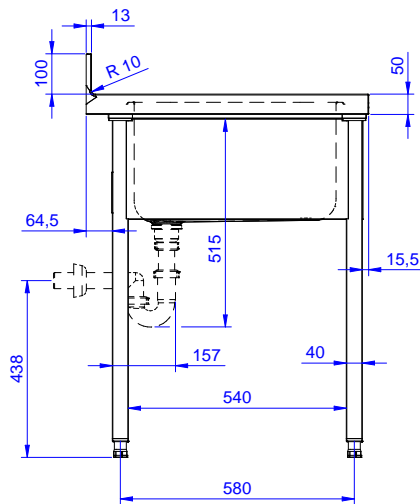

D = Drain

Top

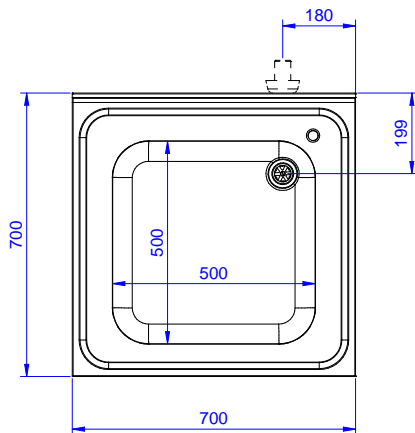
Key Information:

External dimensions, Width:	
132803 (LG716PN)	700 mm
External dimensions, Depth:	700 mm
External dimensions, Height:	1000 mm
Upstand Dimensions, Height:	100 mm
Upstand Dimensions, Depth:	13 mm
Upstand Dimensions, Radius:	R=10
Bowls number	1
Bowl dimensions	500x500xH300
Worktop thickness:	50 mm
Net weight:	28 kg